



# TW34 (Twinaxial 3/4-20) Connectors ONLINE CATALOG

## Contents

CLICK ON ANY LINE TO GO DIRECTLY TO THE INDICATED PAGE

Navigation Guide . . . . .	2
Specifications and interface dimensions . . . . .	3
<b>Cable Connectors</b>	
Cable Plugs . . . . .	3
Bulkhead Mounted Cable Jacks . . . . .	4
Panel Mounted Cable Jacks . . . . .	4
<b>Receptacles</b>	
Bulkhead Jack Receptacles . . . . .	4
Panel Jack Receptacles . . . . .	5
<b>Accessories</b>	
Within-Series Adapters . . . . .	5
<b>Technical Information</b>	
Mounting Figures . . . . .	6
Cable Groups . . . . .	7
Ordering and Warranty . . . . .	8

We have configured this online catalog to take advantage of Acrobat navigation shortcuts (links). However, these links are not visible on the pages— making them visible would compromise the page’s readability.

- Clicking on any entry in the Table of Contents will take you to the indicated page.
- Shown below are the “hot spots” on all of the product pages that will take you to background information on various connector characteristics.
- After you use a link to jump to another page, you can use the “back” arrow in Acrobat’s menu bar to return to the page you jumped from.
- Configure Acrobat Reader to show bookmarks for a table of contents by specific characteristic (for example, cable plugs broken out by cable attachment method).
- To find a specific part number, use Acrobat’s search feature.

In addition, the pages are formatted to fit within the margins of standard laser or inkjet printers—no need to use the “shrink to fit” option when printing pages from Acrobat.

Click [here](#) to go to the Table of Contents

Click on the Delta logo on any page to jump to the table of contents.

Click on the page title to jump to specifications and interface dimensions.

## BNC Cable Jacks

### Panel Jack—Military Clamp for Flexible Cable

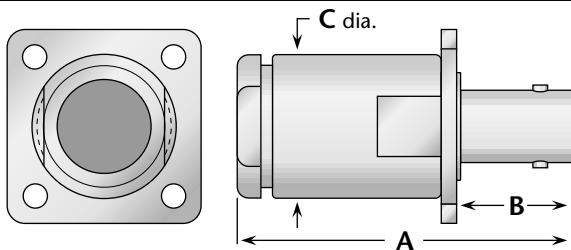

Figure 1

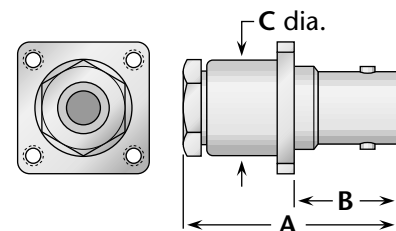

Figure 2

Cable Group	Fig.	Dimensions			Mounting Figure	Plating		Delta P/N	Assembly Procedure/Trim Code
		A	B	C		Body	Contact		
1	1	1.75	.63	.75	33	Nickel	Silver	1011-001-N330	A/20
2, 3	1	1.75	.63	.75	33	Nickel	Silver	1011-004-N330	A/20
5, 6	2	1.16	.55	.50	07	Nickel	Silver	UG-291C/U	A/17

Click here to jump to dimensions for Delta mounting figures.

Click here to jump to a guide to Delta cable groups.

Click here to go to Delta’s website if your computer is configured for Web connection via Acrobat.

## General Description

Delta TW34 series connectors are economical, medium-size twinaxial connectors with 3/4"-20 threaded coupling.

Their characteristic 95Ω impedance makes them ideal for use with RG-22/U and similar Belden, IBM, and other twinaxial cable commonly used in LAN installations.

Plugs in TW34 series contain two male contacts, and jacks contain two female contacts, with mating polarization provided by a key in the jack which engages a keyway in the plug. The insulators of both plugs and jacks are marked to indicate location of the bare-copper wire of the cable conductor pair.

Delta TW34 connectors are designed and manufactured to meet the requirements of MIL-C-3655.

## TW34 Specifications\*

### Plug Interface\*\*

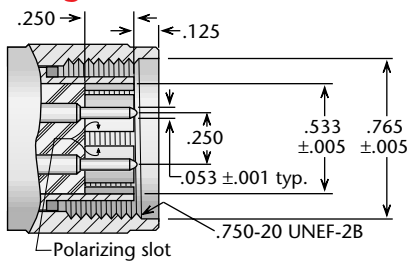

### Jack Interface\*\*

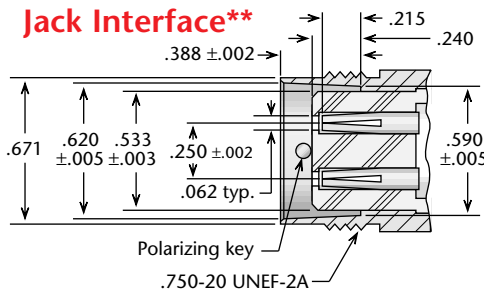

\*These specifications are typical and may not apply to all connectors.

Detailed specifications for individual connectors are available on request.

\*\*Some proportions altered to illustrate detail.

All other specifications are in accordance with the latest issues of MIL-PRF-39012, MIL-C-3655, or other applicable MIL specifications.

### Electrical:

**Nominal Impedance:** 95 ohms.  
**Frequency Range:** DC–200 MHz (Optimal),  
 DC–500 MHz (Useable).  
**Voltage Rating:** 500 volts RMS.  
**Dielectric Withstanding Voltage:** 1,500 volts RMS.  
**Insulation Resistance:** 5,000 megohms.

### Materials/Finishes:

**Insulators:** Teflon per ASTM D1710.  
**Male Contacts:** Brass per ASTM B16.  
**Female Contacts:** Beryllium Copper per ASTM B196.  
**Contact Plating:** Silver per QQ-S-365, or Gold per MIL-G-45204.  
**Gaskets:** Silicone rubber per ZZ-R-765, Class II, Grade 50.  
**Other Metal Parts:** Brass per ASTM B16, plated:  
 Silver per QQ-S-365, or Nickel per QQ-N-290.

## Straight and Right Angle Plugs—Clamp Type for Flexible Cable

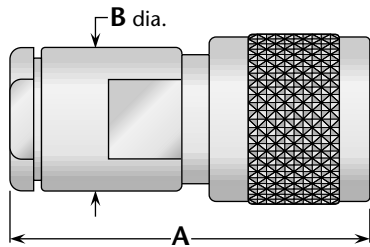

Figure 1

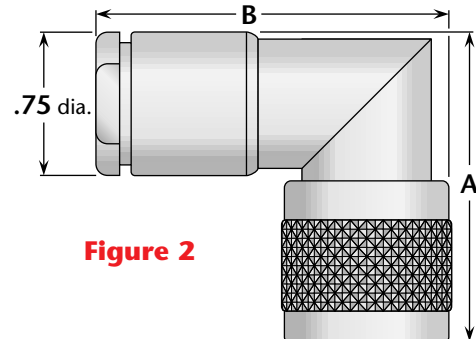
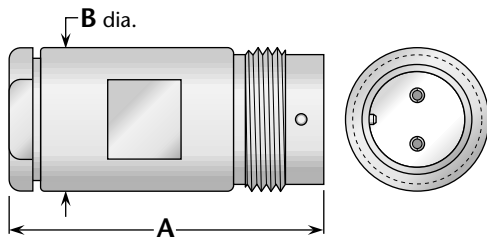

Figure 2

Cable Group	Figure	Dimensions		Plating		Delta P/N	Assembly Procedure/ Trim Code
		A	B	Body	Contact		
27	1	1.88	.75	Nickel	Silver	2601-099-N000	***
28	1	1.88	.75	Nickel	Silver	UG-421B/U	***
28	2	1.56	1.88	Nickel	Silver	2604-070-N000	***
29	1	1.88	.75	Nickel	Silver	2601-201-N000	***
29	2	1.56	1.88	Nickel	Silver	2604-201-N000	***

## Cable Jacks



**Figure 1**  
(Straight jack)

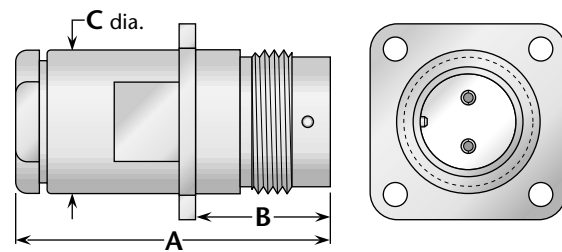

**Figure 2**  
(Panel jack)

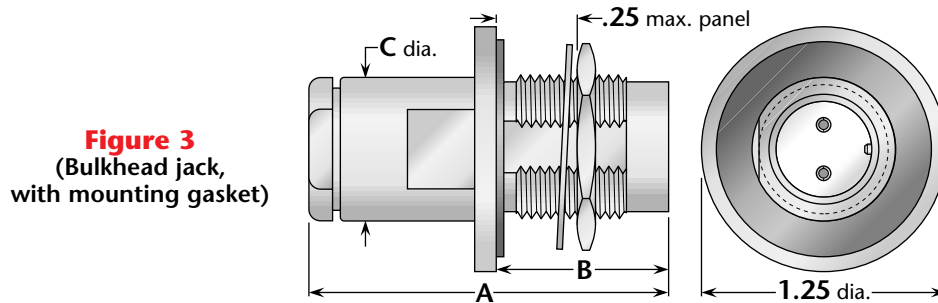

**Figure 3**  
(Bulkhead jack,  
with mounting gasket)

Cable Group	Fig.	Dimensions			Mounting Figure	Plating		Delta P/N	Assembly Procedure/Trim Code
		A	B	C		Body	Contact		
28	1	1.59	.75	—	—	Nickel	Silver	2608-070-N000	***
28	2	1.75	.69	.75	33	Nickel	Silver	UG-423B/U	***
28	3	1.75	.88	.75	51	Nickel	Silver	2616-070-N511	***
29	2	1.75	.69	.75	33	Nickel	Silver	2611-201-N331	***
29	3	1.75	.88	.75	51	Nickel	Silver	2616-201-N511	***

## Bulkhead Receptacles—Solder Pot Contact

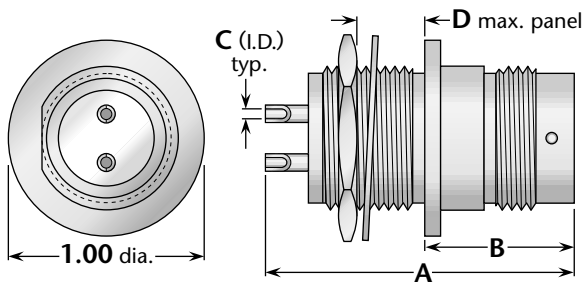

**Figure 1**  
(Bulkhead jack receptacle, front mount)

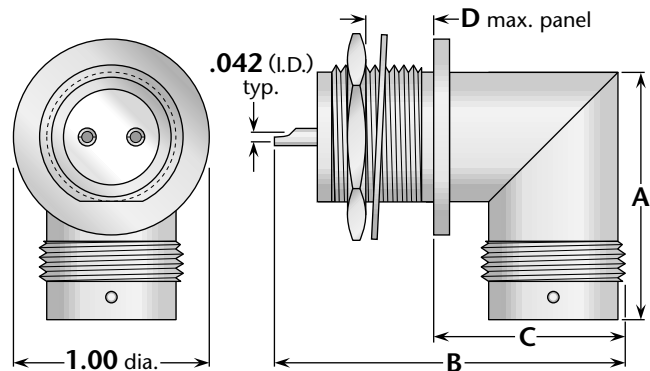

**Figure 2**  
(Right angle bulkhead jack receptacle)

Figure	Dimensions				Mounting Figure	Plating		Delta P/N
	A	B	C	D		Body	Contact	
1	1.58	.785	.042	.25	51	Nickel	Silver (C)	2620-000-N511
2	1.53	1.75	.970	.25	51	Nickel	Silver (C)	2622-000-N511

\*\*\*Contact factory for cable assembly instructions. • (C) in contact plating column indicates captive contact.

## Panel Jack Receptacle—Solder Pot Contact

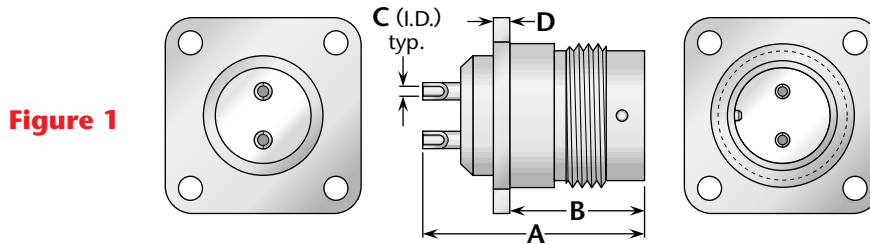
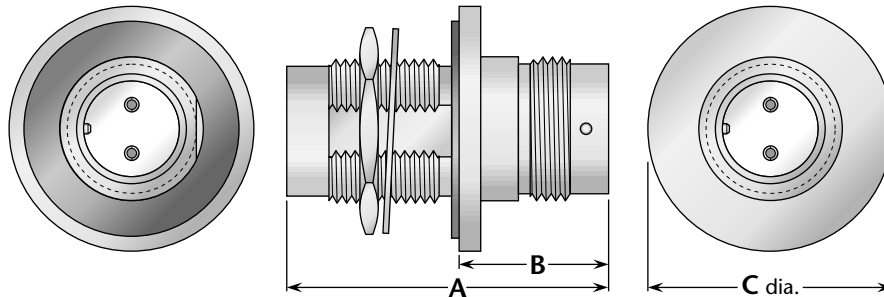

Figure	Dimensions				Mounting Figure	Plating		Delta P/N
	A	B	C	D		Body	Contact	
1	1.18	.71	.059	.080	33	Nickel	Silver (C)	UG-422/U

## Bulkhead Jack-Jack Adapter (Connects two plugs)



Dimensions			Max. Panel	Mounting Figure	Plating		Delta P/N
A	B	C			Body	Contact	
1.67	.88	1.25	.25	51	Nickel	Silver (C)	UG-493A/U

## Straight and Right Angle Adapters

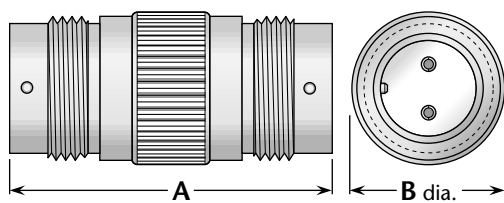

**Figure 1**  
(Straight jack-jack; connects two plugs)

**Figure 2**  
(Right angle jack-plug; connects one plug and one jack)

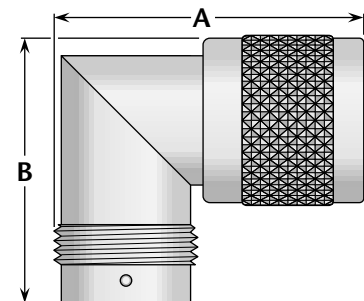
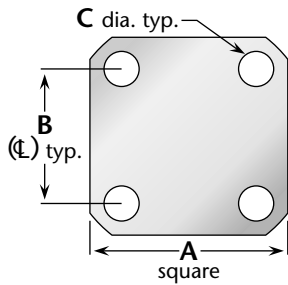

Figure	Dimensions		Plating		Delta P/N
	A	B	Body	Contact	
1	1.67	.75	Nickel	Silver (C)	2626-000-N000
2	1.56	1.38	Nickel	Silver (C)	UG-981/U

(C) in contact plating column indicates captive contact.

## Connector Flanges (Panel mounted connectors)



### 4-hole flanges

Figure	A	B	C
04	1/2	.360	.089
05	1/2	.340	.102
07	11/16	.500	#3-56 tap
08	11/16	.500	.136
09	11/16	.500	.125
10	11/16	.500	.120
12	11/16	.500	.109
18	3/4	.531	.136
26	1	.718	#6-32 tap
27	1	.718	#4-40 tap
30	1	.718	.166
32	1	.718	.136
32A	1	.718	.136*
33	1	.718	.125
34	13/32	.812	.150
36	13/16	.906	#6-32 tap
39	13/16	.906	.152
40	13/16	.906	.125
45	2	1.437	.257
91	.375	.250	.067
91A	.375	.232	.093

\* Countersunk to .245 dia.

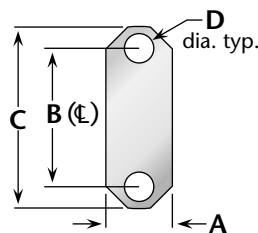

### 2-hole flanges

Figure	A	B	C	D
92	.223	.481	.625	.102
92A	.260	.481	.625	.102
95	.640	1.015	1.30	.125

## Panel Cutouts (Bulkhead mounted connectors)

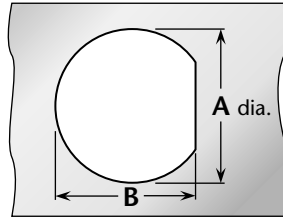

### D-Hole

Figure	A	B
51	.755	.723
54	.630	.598
55	.630	.583
57	.557	.531
59	.505	.473
62	.442	.410
63	.407	.362
65	.380	.348
66	.319	.292
67	.255	.236
68	.195	.176

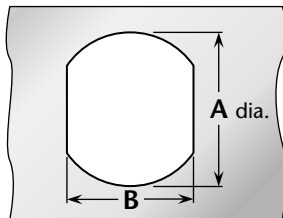

### Double D-Hole

Figure	A	B
69	.755	.692
72	.630	.536
75	.380	.341
84	.319	.278

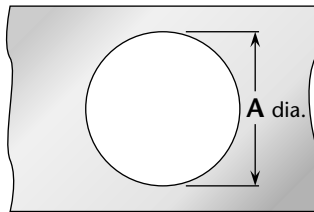

### Round Hole

Figure	A
82	.255
89	.380

## P.C. Board Drilling

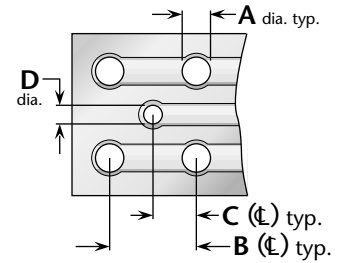

(PCB traces are shown for illustrative purpose only, and are not representative of actual circuitry.)

### Coaxial connectors

Figure	A	B	C	D
PCB01	.067	.400	.200	.045
PCB02	.045	.500	.250	.045
PCB03	.067	.300	.150	.035
PCB05	.067	.200	.100	.055
PCB06	.067	.200	.100	.045
PCB07	.045	.177	.088	.045
PCB08	.032	.100	.050	.032

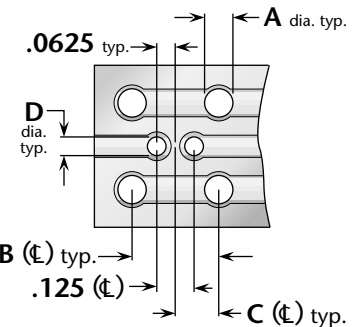

(PCB traces are shown for illustrative purpose only, and are not representative of actual circuitry.)

### Twinax connectors

Figure	A	B	C	D
PCB04	.045	.500	.250	.045

<b>Cable Group Finder</b>			
<b>Cable</b>	<b>Group</b>	<b>Cable</b>	<b>Group</b>
RG-5, 5A, B	1A	RG-225	3C
RG-6, 6A	1B	RG-228A	20
RG-8, 8A	2A	RG-302	22
RG-9, 9A, B	3A	RG-303	23
RG-10	15	RG-304	24
RG-11, 11A	2B	RG-316	9A
RG-12	15	RG-316DS	10
RG-13A	3B	RG-393	4
RG-14A	16	RG-400	6A
RG-17A	17	RG-401	12
RG-18A	18	RG-402	13
RG-21, 21A	1A	RG-405	14
RG-22, 22A, B	28	M17/2	1B
RG-55, 55B	6B	M17/6	2B
RG-55A	6A	M17/15	28
RG-58, 58A, C	5	M17/28	5
RG-59, 59A, B	7A	M17/29	7A
RG-62, 62A, B, C	7A	M17/30	7A
RG-71, 71A, B	7B	M17/45	27
RG-108, 108A	27	M17/73	1A
RG-115A	19	M17/162	1A
RG-118A	20	M17/112	1C
RG-122	8A	M17/74	2A
RG-126	21	M17/75	3A
RG-141, 141A	5	M17/127	3C
RG-142, 142A	6A	M17/77	3B
RG-142B	6B	M17/60	6A
RG-143, 143A	1C	M18/84	6A
RG-174	9A	M17/128	6A
RG-174DS	10	M17/97	7A
RG-178, 178A, B	11	M17/54	8A
RG-179A, 179B	9B	M17/95	8B
RG-180, 180A, B	8B	M17/137	8B
RG-187, 187A	9B	M17/152	9A
RG-188, 188A	9A	M17/93	11
RG-195	8B	M17/129	12
RG-196, 196A	11	M17/130	13
RG-210	7A	M17/133	14
RG-212	1C	M17/78	16
RG-213	2A	M17/165	16
RG-214	3A	M17/176	30
RG-215	15	AT&T 735A	31
RG-217	16	Belden 8281	26
RG-218	17	Belden 9207	29
RG-219	18	Dearborn 6207	29
RG-222	1C	IBM 7362211	29
RG-223	6A		

<b>Delta Cable Groups</b>	
<b>Group</b>	<b>Cables</b>
1	1A RG-5, 5A, 5B, 21, 21A; M17/73, /162
	1B RG-6, 6A; M17/2
	1C RG-143, 143A, 212, 222; M17/73, /112, /162
2	2A RG-8, 8A, 213; M17/74
	2B RG-11, 11A; M17/6
3	3A RG-9, 9A, 9B, 214; M17/75
	3B RG-13A, 216; M17/77
	3C RG-225; M17/127
4	RG-393; M17/127
5	RG-58, 58A, 58C, 141, 141A; M17/28, /111
6	6A RG-55A, 142, 142A, 223, 400; M17/60, /84, /128
	6B RG-55, 55B, 142B; M17/60, /84
7	7A RG-59, 59A, 59B, 62, 62A, 62B, 62C, 210; M17/29, /30, /97
	7B RG-71, 71A, 71B; M17/90
8	8A RG-122; M17/54
	8B RG-180, 180A, 180B, 195; M17/95, /137
9	9A RG-174, 188, 188A, 316; M17/152
	9B RG-179A, 179B, 187, 187A; M17/94, /136
10	Double-Shielded RG-174, 316; M17/152
11	RG-178, 178A, 178B, 196, 196A; M17/93
12	.250" semi-rigid; RG-401; M17/129
13	.141" semi-rigid; RG-402; M17/130
14	.085" semi-rigid; RG-405; M17/133
15	RG-10, 12, 215; M17/6, /74
16	RG-14A, 217; M17/78, /165
17	RG-17A, 218
18	RG-18A, 219
19	RG-115A
20	RG-118A, 228A
21	RG-126
22	RG-302
23	RG-303
24	RG-304
25	Special 8X cable; contact factory for details.
26	Belden 8281
27	RG-108, 108A; M17/45
28	RG-22, 22A, 22B; M17/15
29	Belden 9207; Dearborn 6207; IBM 7362211
30	M17/176
31	AT&T 735A



## Warranty

We warrant our parts to be free from defects in materials and workmanship for one year from date of purchase. During that time, we will repair or replace (at our option) any parts found to be defective.

This warranty does not apply to parts which have been modified, used in conditions exceeding Delta or military specifications, or disassembled. We will not, under any circumstances, be responsible for consequential or incidental damages or installation costs.

No other warranties apply, and no other liability may be assumed or extended by representatives or distributors.

## Returns

Returns will be accepted only with a Return Authorization number issued by Delta, and are subject to inspection and acceptance upon arrival. Restocking charges will be determined prior to issuance of Return Authorization.

All claims for shortages must be made within 30 days of receipt by customer.

## Ordering Information

Orders are subject to the terms and conditions on our order acknowledgement, which may only be modified by written agreement prior to sale. Order changes, cancellation, or termination will be accepted only with written approval from Delta Electronics Manufacturing.

## Copyright, Trademarks, and Patents

Entire contents copyright 2003, Delta Electronics Manufacturing Corporation. Reproduction rights are hereby granted for, and specifically limited to, printing or other reproduction of drawings and specifications for inclusion in specification or source control drawings, or for purchasing procedures, by Delta customers only.

*Heli-Grip*, *PressMount*, and the New England Craftsmanship logo are trademarks. The Heli-Grip design is covered by U.S. and foreign patents.

Delta Electronics Manufacturing Corporation  
416 Cabot Street, P.O. Box 53  
Beverly, MA 01915  
FSCM/CAGE 00795

Catalog # TW34pdf 1.2 (7/09)